

Ecophon Connect™

precision grid system for perfect results



Ecophon®
SAINT-GOBAIN

A SOUND EFFECT ON PEOPLE

Ecophon Connect™

a flexible and precise grid system

Connect grid is a robust, time saving system that supports flexible and aesthetically pleasing ceiling solutions. The high quality of the materials and the attention to detail in design, results in a convenient, fast and cost-efficient installation process.

System components with high quality materials and precision

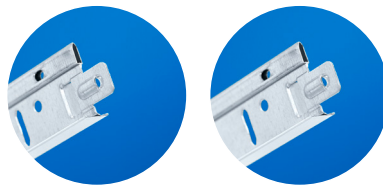

Main Runner and Cross Tee
(see number 2, 3, 4 on sketch below)

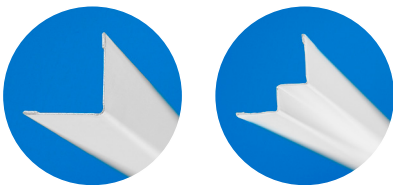

Wall Trims
(see number 8, 9 on sketch below)



Channel Trim



Space Bar

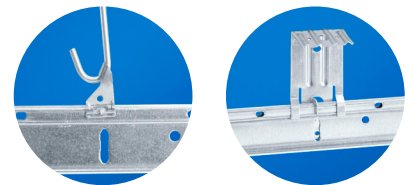

Adjustable Hangers and Direct Fixing Brackets
(see number 5, 7 on sketch below)

Connect grid consists of the following components:

- Main Runner and Cross Tee
- Wall Trims
- Adjustable Hangers and Direct Fixing Brackets
- Channel Trims
- Space Bars

To ensure the success of the system it is important to install the grid according to Ecophon instructions and with recommended components.

Ecophon installation instructions and drawings can be downloaded at www.ecophon.co.uk under 'Products.' (eg M01).

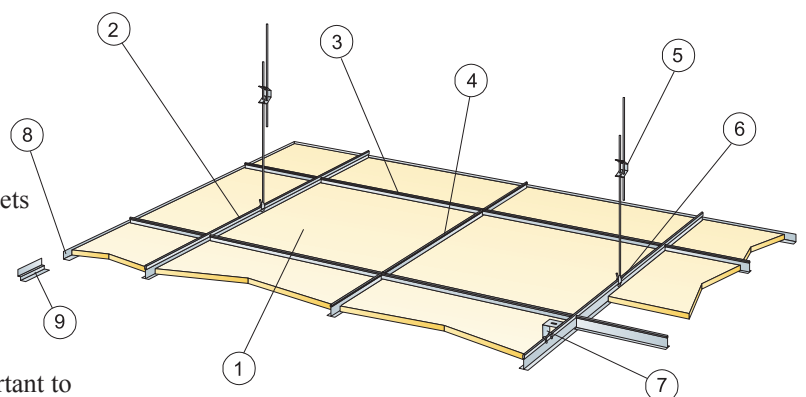

Connect Main Runner



- Rigid construction for stable installation
- High precision and excellent loading capacity
- Unique design for secure fixing of Connect hanger clip
- Available in lengths of 3000 and 3700 mm
- Height 38 mm

Connect Cross Tee



- Has a long locking tab for fast and stable connection
- Distinctive click sound that indicates when the profile is in position
- Easy to demount without any tools
- Available in lengths of 150, 300, 600, 625, 900, 1200, 1250, and 1800 mm (T24)



Grid system for trouble-free installation and perfect result

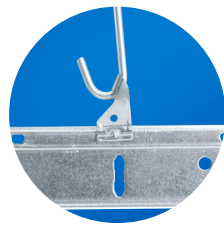
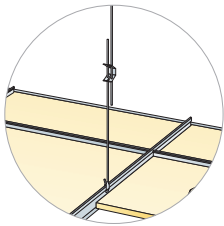

Connect Adjustable Hangers and Hanger Brackets

Connect adjustable hangers are available in various lengths and surface finishes. Hanging brackets are used to facilitate the installation of adjustable hangers on your main runner to enable the hanger to be positioned exactly where needed.

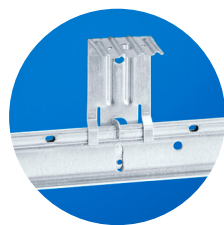
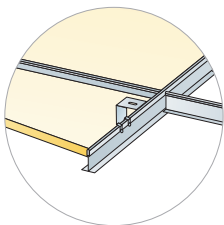

Connect Direct Fixing Brackets

Used for fixed installation on the main runner, e.g. for sloped ceilings and when a short drop height is desired. Requires a flat fixing surface.

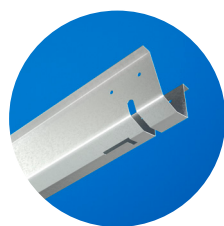
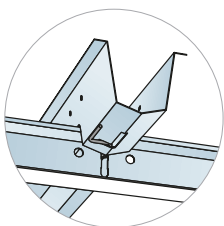

Connect Space Bar

A hidden profile that is mounted on the main runner (T24) and secured with a locking pin to create precise angles and extra stability in mounting the systems Ds and Lp.

Advantages of Ecophon Connect™:

- a flexible and versatile system
- high quality materials
- Precision manufacture
- easy to use and time saving on site
- recyclable



Connect Shadow Channel Trim

Used for easy installation of free hanging suspended ceilings.



Connect Shadow-line Trim

The profile has a pleated form that creates a narrow shadow against the wall.



Connect Wall Trim

Standard wall trim for wall connection.

Connect system

System	Main runner and Cross tee	Wall trim detail sketch *	Wall Shadow-line trim detail sketch *	Floating Ceiling sketch * (free hanging installation)	Level changes detail sketch *
Focus A	T15/T24	T1_A11 T1_A16	T1_A12	T8_A11	T7_A13 T7_A15 T7_A16 (T24) T7_A17 (T24)
Focus Dg	T24 HD	T1_DG11	T1_DG12	T8_Dg14	
Focus Ds	T24 HD	T1_D19 T1_D110 T1_D111		T8_Ds17 T8_Ds51	T7_D17 T7_DS113
Focus E	T15/T24	T1_E11 T1_E12 T1_E110 T1_E113	T1_E13 T1_E14 T1_E15	T8_E12 T8_E14 (T24) T1_E51 (T24)	T7_E15 (T24) T7_E17
Focus Lp	T24 HD	T1_LP11 T1_LP12			
Master A	T24	T1_A41 T1_A45	T1_A42	T8_A11	(T7_A111)* (T7_A15)*
Master Ds	T24 HD	T1_D42			T7_D17
Master E	T24	T1_E42	T1_E44	T8_E14 T8_E41	(T7_E15)*
Master Rigid A	T24	T1_A111			
Master Rigid Dp	T24		T1Dp_11		
Master Rigid E	T24	T1_E114			
Gedina A Advantage A	T15/T24	T1_A01 T1_A06	T1_A02		
Gedina E Advantage E	T15/T24	T1_E01 T1_E02 T1_E010	T1_E03 T1_E04 T1_E05	T8_E01	T7_E07
Super G Plus	Recessed Profile	ST1_A43			

HD is a robust grid for extra stability. * For vertical absorbers, 20mm Focus absorber is used

In order to see how the detail looks, see www.ecophon.com/uk click on products, scroll down to the requested product, scroll down to installation and click on yellow solutions button.

NB For Super G 35mm & 20mm requires a Channel Trim at the wall junction. For all Hygiene products, please refer to install diagrams. All C3 & C4 Grid systems use Channel Trim for wall junction rather than Angle Trim.

Standard Colours



Connect white 01
NCS S 0500-N
Gloss 20

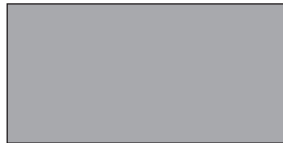

Connect grey 01 metallic
NCS S 2502-B
Variation in gloss and
colour may occur.



Connect black 01 matt
NCS S 9000-N
Gloss 3

Corrosion class

C1

Frame of galvanised steel and a cover made of galvanized lacquered steel. For non-corrosive environments. Corrosive class C1. EN ISO 12944-2.

C3

Frame of galvanized steel with extra corrosion protection and a cover made of galvanized lacquered steel. For wet or moderately corrosive environments such as restaurant kitchens and shower areas. Corrosion class C3.

C4

Frame and cover of acid proof stainless steel. For highly corrosive environments such as swimming pools or industries that use chlorine based cleaners. Corrosion class C4. EN ISO 12944-2.

Construction height and demounting

System	Adjustable hanger, min ODS	Direct fixing bracket, min ODS	Minimum demountability height
Focus A	100 mm	50 mm	120 mm 130mm (1200x1200mm)
Focus Dg	115 mm	65 mm	30 mm
Focus Ds	105 mm	65 mm	30 mm 50 mm (1200x1200 mm)
Focus E	110 mm	60 mm	120 mm 160 mm (T15 1200x1200 mm)
Focus Lp	105 mm 109 mm using Connect Space Bar Connector		20 mm
Master A	110 mm	50 mm	170 mm 200 mm (1200x1200 mm)
Master Ds	140 mm	95 mm	50 mm
Master E	110 mm	60 mm	170 mm
Master Rigid A	100 mm		120 mm 170 mm with Extra Bass
Master Rigid Dp	115 mm		20 mm 170 mm with Extra Bass
Master Rigid E	110 mm		120 mm 170 mm with Extra Bass
Gedina A Advantage A	100 mm	50 mm	120 mm
Gedina E Advantage E	110 mm	60 mm	T15 100 mm T24 90 mm
Combison Duo A	100 mm	80 mm	220 mm
Combison Duo E	110 mm	90 mm	230 mm
Combison Uno A	100 mm	50 mm	200 mm
Combison Uno Ds	105 mm		40 mm

ODS - overall depth of system

Corridor System	Minimum height ODS	Minimum demountability height
Focus A	40 mm	65 mm
Focus D/A	50 mm	120 mm
Focus Ds	55 mm	30 mm
Focus E	50 mm	75 mm
Master Rigid Dp	115 mm	20 mm
Gedina D/A	50 mm	120 mm

Edge overview

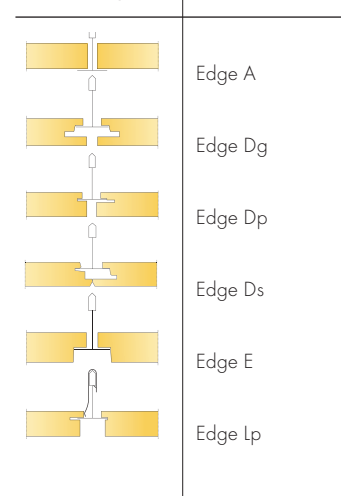

*There are also edges B, F, SQ for direct installation with glue or screws.

The construction height is the distance between the soffit and tile's underside, large delta (Δ). Little delta (δ) is the minimum demounting depth.



A SOUND EFFECT ON PEOPLE

Ecophon dates back to 1958, when the first sound absorbers from glass wool were produced in Sweden to improve the acoustic working environment. Today the company is a global supplier of acoustic systems that contribute to good room acoustics and a healthy indoor environment with the focus on offices, education, health care and industrial manufacturing premises. Ecophon is part of the Saint-Gobain Group and has sales units and distributors in many countries. Ecophon efforts are guided by a vision of earning global leadership in room acoustic comfort through sound-absorbing systems, enhancing end-user performance and wellbeing. Ecophon maintains an ongoing dialogue with government agencies, working environment organisations and research institutes, and is involved in formulating national standards in the field of room acoustics where Ecophon contributes to a better working environment wherever people work and communicate.

www.ecophon.com

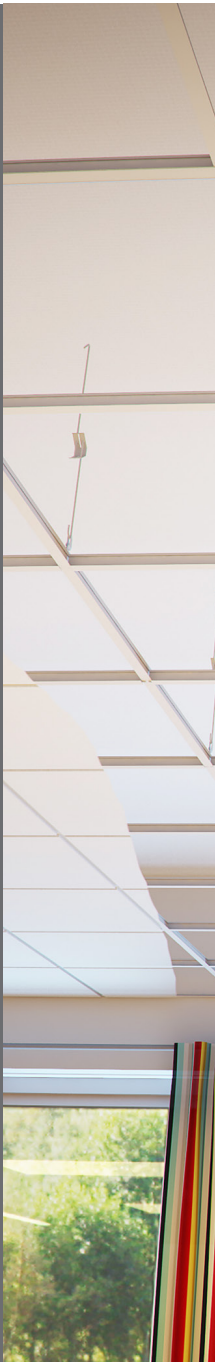

www.ecophon.com